

| You are in: Lozier > Products > Wall Section (Wire Grid 1 Side, Mtk Other Side)

# Wall Section (Wire Grid 1 Side, Mtk Other Side)

Part Number:

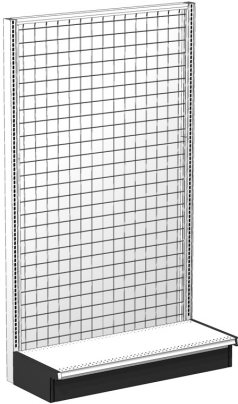

## Product Details:

### Standard Duty- Load Rating

- Low Base -15,000 inch lbs unbalanced
- 06 Base- 12,000 inch lbs unbalanced

### Heavy Duty- Load Rating

- Low Base -18,000 inch lbs unbalanced
- 06 Base- 20,000 inch lbs unbalanced

- Grid retainers and Retainer Backs are used to add any combination of single, double, or triple back set to a wall or gondola section.
- The respective single, double, or triple back retainers are detailed in the Wire Grid Back Retainer Chart.
- RBE\_ style grid or hardboard backs can be used interchangeably in any of the grid retainer styles/postions.

## DIMENSIONS

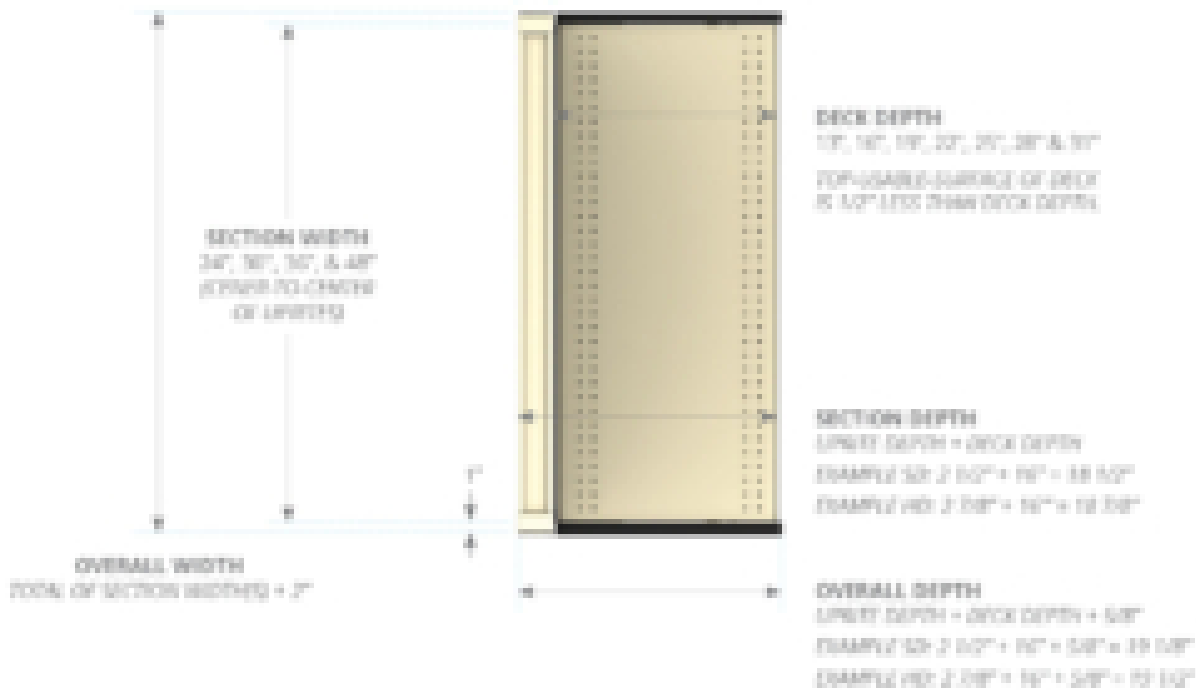
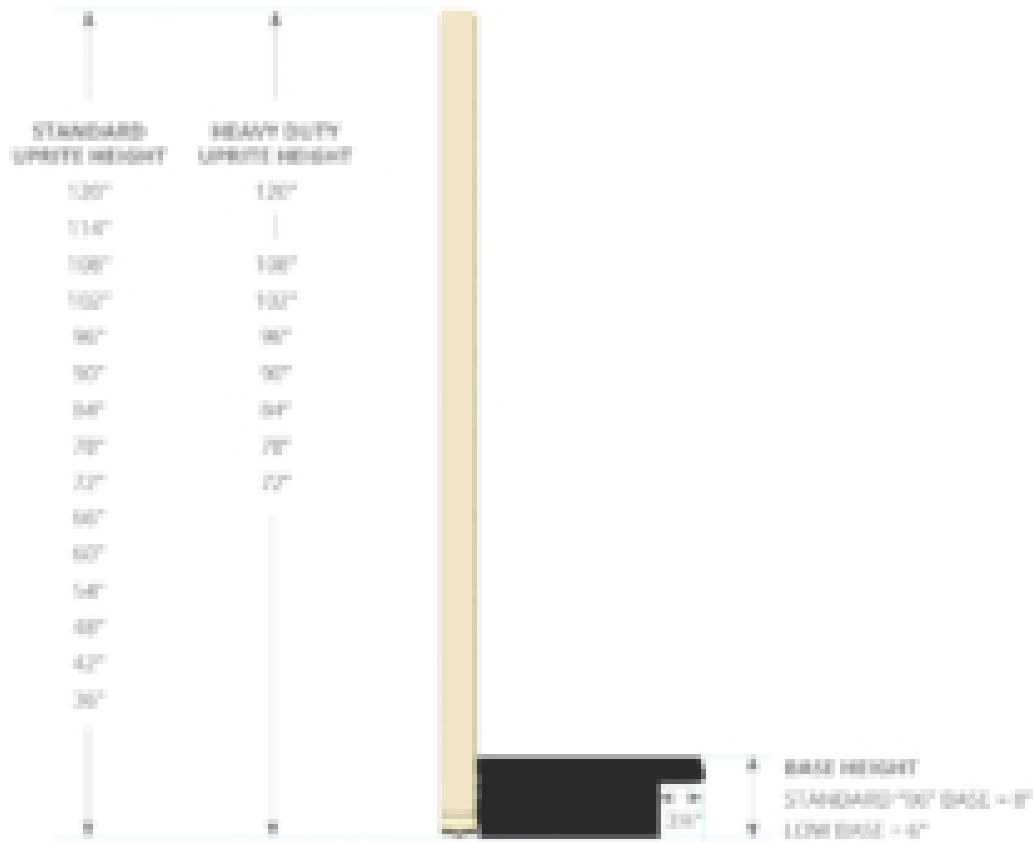

## WIRE BACK OPTIONS

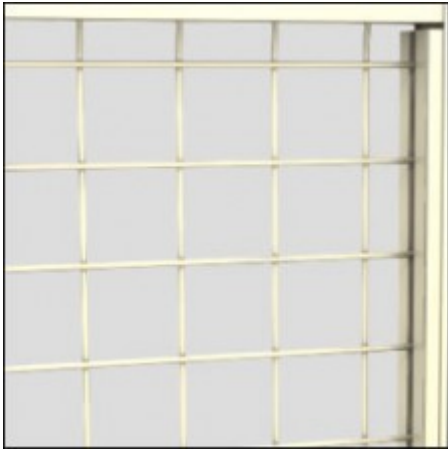

WG = 3x3 Wire Grid

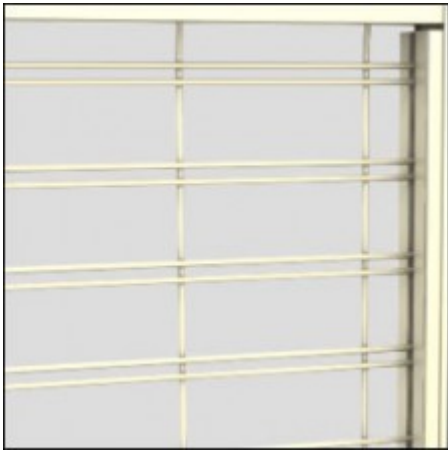

SG = Slot Grid



MG = Multi-Grid



LG = Louver Grid

### WIRE RETAINER OPTIONS



S = Single Back

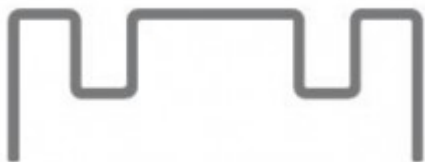

D = Double Back



T = Triple Back

---

## How to Order

---

	STARTER QTY.	ADD- ON QTY.
<b>A.</b> Uprite Base Bracket	2	1
<b>B.</b> (Standard or Heavy Duty)	2	1
<b>C.</b> Deck (Standard or Heavy Duty)	1	1
<b>D.</b> Base Front (Open or Closed)	1	1
<b>E.</b> Top Rail	1	1
<b>F.</b> Retainers for Double Backs	See Retainer Chart	See Retainer Chart
Back Retainer		
<b>G.</b> Bottom Rail (Heavy Duty 3' & 4' Sections)	1	1
Splicer Rail (Sections 102-		
<b>H.</b> 120H) Use 2 top rails for splicer 2' and 30" sections	1	1
Grid/MTK backs		
<b>I.</b> (1pc to 96H 2pc 102- 120H)	See Back Chart	See Back Chart
<b>J.</b> Base End Trim (Pair)	1	0
<b>K.</b> Uprite End Trim	2	0

## STARTER

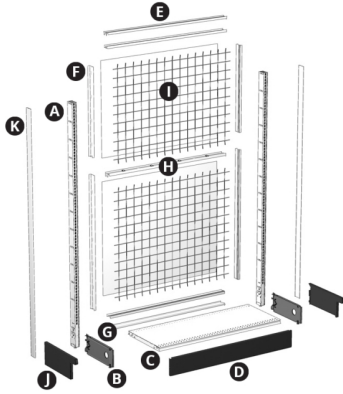

## ADD-ON

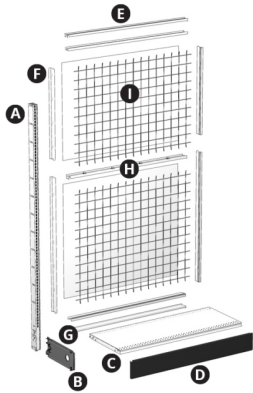

### ORDERING INSTRUCTIONS FOR WALL SECTIONS GRID BACK ONE SIDE, MTK BACK OTHER SIDE

	STARTER QTY.	ADD- ON QTY.
Upright (Standard or A. Heavy Duty)	2	1
Base Set (could be different depth or base height on either side) (Standard or B. Heavy Duty)	1	1
C. Top Rail	1	1

Back Retainer Bottom Rail (Heavy Duty 3' & D. 4' sections)	1	1
	See	See
Retainers for Double E. Backs	Retainer Chart	Retainer Chart
		See
Grid backs (1pc to F. 96H 2pc 102-120H)	See Back Chart	Back Chart
G. Upright End Trim	2	0

### WIREGRID BACK RETAINER CHART

Island or Wall Section Height	Section Width	Single Centered Back	Grid Flush Both Sides	Grid Flush Both Sides Mtk Ptd 2 Sides Center
36	2'	Qty 2 RES30 Qty 2 RES24	Qty 2 RED30 Qty 2 RED24	Qty 2 RET30 Qty 2 RET24
36	30"	Qty 4 RES30	Qty 4 RES30	Qty 4 RET30
36	3'	Qty 3 RES30 Qty 2 RES36	Qty 3 RED30 Qty 2 RED36	Qty 3 RET30 Qty 2 RET36
36	4'	Qty 3 RES30 Qty 2 RES48	Qty 3 RED30 Qty 2 RED48	Qty 3 RET30 Qty 2 RET48
42	2'	Qty 2 RES36 Qty 2 RES24	Qty 2 RED36 Qty 2 RED24	Qty 2 RET36 Qty 2 RET24

42	30"	Qty 2 RES36 Qty 2 RES30	Qty 2 RED36 Qty 2 RED30	Qty 2 RET36 Qty 2 RET30
42	3'	Qty 4 RES36	Qty 4 RED36	Qty 4 RET36
42	4'	Qty 2 RES36 Qty 2 RES48	Qty 2 RED36 Qty 2 RED48	Qty 2 RET36 Qty 2 RET48
48	2'	Qty 2 RES42 Qty 2 RES24	Qty 2 RED42 Qty 2 RED24	Qty 2 RET42 Qty 2 RET24
48	30"	Qty 2 RES42 Qty 2 RES30	Qty 2 RED42 Qty 2 RED30	Qty 2 RET42 Qty 2 RET30
48	3'	Qty 2 RES42 Qty 2 RES36	Qty 2 RED42 Qty 2 RED36	Qty 2 RET42 Qty 2 RET36
48	4'	Qty 2 RES42 Qty 2 RES48	Qty 2 RED42 Qty 2 RED48	Qty 2 RET42 Qty 2 RET48
54	2'	Qty 2 RES48 Qty 2 RES24	Qty 2 RED48 Qty 2 RED24	Qty 2 RET48 Qty 2 RET24
54	30"	Qty 2 RES48 Qty 2 RES30	Qty 2 RED48 Qty 2 RED30	Qty 2 RET48 Qty 2 RET30
54	3'	Qty 2 RES48 Qty 2 RES36	Qty 2 RED48 Qty 2 RED36	Qty 2 RET48 Qty 2 RET36
54	4'	Qty 4 RES48	Qty 4 RED48	Qty 4 RET48



60	2'	Qty 2 RES48 Qty 2 RUS06 Qty 2 RES24	Qty 2 RED48 Qty 2 RUD06 Qty 2 RED24	Qty 2 RET48 Qty 2 RUT06 Qty 2 RET24
60	30"	Qty 2 RES48 Qty 2 RUS06 Qty 2 RES30	Qty 2 RED48 Qty 2 RUD06 Qty 2 RED30	Qty 2 RET48 Qty 2 RUT06 Qty 2 RET30
60	3'	Qty 2 RES48 Qty 2 RUS06 Qty 2 RES36	Qty 2 RED48 Qty 2 RUD06 Qty 2 RED36	Qty 2 RET48 Qty 2 RUT06 Qty 2 RET36
60	4'	Qty 4 RES48 Qty 2 RUS06	Qty 4 RED48 Qty 2 RUD06	Qty 4 RET48 Qty 2 RUT06
66	2'	Qty 2 RES48 Qty 2 RUS12 Qty 2 RES24	Qty 2 RED48 Qty 2 RUD12 Qty 2 RED24	Qty 2 RET48 Qty 2 RUT12 Qty 2 RET24
66	30"	Qty 2 RES48 Qty 2 RUS12 Qty 2 RES30	Qty 2 RED48 Qty 2 RUD12 Qty 2 RED30	Qty 2 RET48 Qty 2 RUT12 Qty 2 RET30
66	3'	Qty 2 RES48 Qty 2 RUS12 Qty 2 RES36	Qty 2 RED48 Qty 2 RUD12 Qty 2 RED36	Qty 2 RET48 Qty 2 RUT12 Qty 2 RET36
66	4'	Qty 4 RES48 Qty 2 RUS12	Qty 4 RED48 Qty 2 RUD12	Qty 4 RET48 Qty 2 RUT12

72	2'	Qty 2 RES48 Qty 2 RUS18 Qty 2 RES24	Qty 2 RED48 Qty 2 RUD18 Qty 2 RED24	Qty 2 RET48 Qty 2 RUT18 Qty 2 RET24
72	30"	Qty 2 RES48 Qty 2 RUS18 Qty 2 RES30	Qty 2 RED48 Qty 2 RUD18 Qty 2 RED30	Qty 2 RET48 Qty 2 RUT18 Qty 2 RET30
72	3'	Qty 2 RES48 Qty 2 RUS18 Qty 2 RES36	Qty 2 RED48 Qty 2 RUD18 Qty 2 RED36	Qty 2 RET48 Qty 2 RUT18 Qty 2 RET36
72	4'	Qty 4 RES48 Qty 2 RUS18	Qty 4 RED48 Qty 2 RUD18	Qty 4 RET48 Qty 2 RUT18
78	2'	Qty 2 RES48 Qty 2 RUS24 Qty 2 RES24	Qty 2 RED48 Qty 2 RUD24 Qty 2 RED24	Qty 2 RET48 Qty 2 RUT24 Qty 2 RET24
78	30"	Qty 2 RES48 Qty 2 RUS24 Qty 2 RES30	Qty 2 RED48 Qty 2 RUD24 Qty 2 RED30	Qty 2 RET48 Qty 2 RUT24 Qty 2 RET30
78	3'	Qty 2 RES48 Qty 2 RUS24 Qty 2 RES36	Qty 2 RED48 Qty 2 RUD24 Qty 2 RED36	Qty 2 RET48 Qty 2 RUT24 Qty 2 RET36
78	4'	Qty 4 RES48 Qty 2 RUS24	Qty 4 RED48 Qty 2 RUD24	Qty 4 RET48 Qty 2 RUT24

84	2'	Qty 2 RES48 Qty 2 RUS30 Qty 2 RES24	Qty 2 RED48 Qty 2 RUD30 Qty 2 RED24	Qty 2 RET48 Qty 2 RUT30 Qty 2 RET24
84	30"	Qty 2 RES48 Qty 2 RUS30 Qty 2 RES30	Qty 2 RED48 Qty 2 RUD30 Qty 2 RED30	Qty 2 RET48 Qty 2 RUT30 Qty 2 RET30
84	3'	Qty 2 RES48 Qty 2 RUS30 Qty 2 RES36	Qty 2 RED48 Qty 2 RUD30 Qty 2 RED36	Qty 2 RET48 Qty 2 RUT30 Qty 2 RET36
84	4'	Qty 4 RES48 Qty 2 RUS30	Qty 4 RED48 Qty 2 RUD30	Qty 4 RET48 Qty 2 RUT30
90	2'	Qty 2 RES48 Qty 2 RUS36 Qty 2 RES24	Qty 2 RED48 Qty 2 RUD36 Qty 2 RED24	Qty 2 RET48 Qty 2 RUT36 Qty 2 RET24
90	30"	Qty 2 RES48 Qty 2 RUS36 Qty 2 RES30	Qty 2 RED48 Qty 2 RUD36 Qty 2 RED30	Qty 2 RET48 Qty 2 RUT36 Qty 2 RET30
90	3'	Qty 2 RES48 Qty 2 RUS36 Qty 2 RES36	Qty 2 RED48 Qty 2 RUD36 Qty 2 RED36	Qty 2 RET48 Qty 2 RUT36 Qty 2 RET36
90	4'	Qty 4 RES48 Qty 2 RUS36	Qty 4 RED48 Qty 2 RUD36	Qty 4 RET48 Qty 2 RUT36

96	2'	Qty 2 RES48 Qty 2 RUS42 Qty 2 RES24	Qty 2 RED48 Qty 2 RUD42 Qty 2 RED24	Qty 2 RET48 Qty 2 RUT42 Qty 2 RET24
96	30"	Qty 2 RES48 Qty 2 RUS42 Qty 2 RES30	Qty 2 RED48 Qty 2 RUD42 Qty 2 RED30	Qty 2 RET48 Qty 2 RUT42 Qty 2 RET30
96	3'	Qty 2 RES48 Qty 2 RUS42 Qty 2 RES36	Qty 2 RED48 Qty 2 RUD42 Qty 2 RED36	Qty 2 RET48 Qty 2 RUT42 Qty 2 RET36
96	4'	Qty 4 RES48 Qty 2 RUS42	Qty 4 RED48 Qty 2 RUD42	Qty 4 RET48 Qty 2 RUT42
102	2'	Qty 4 RES48 Qty 4 RES24	Qty 4 RED48 Qty 4 RED24	Qty 4 RET48 Qty 4 RET24
102	30"	Qty 4 RES48 Qty 4 RES30	Qty 4 RED48 Qty 4 RED30	Qty 4 RET48 Qty 4 RET30
102	3'	Qty 4 RES48 Qty 4 RES36	Qty 4 RED48 Qty 4 RED36	Qty 4 RET48 Qty 4 RET36
102	4'	Qty 8 RES48	Qty 8 RED48	Qty 8 RET48
108	2'	Qty 4 RES48 Qty 2 RUS06 Qty 4 RES24	Qty 4 RED48 Qty 2 RUD06 Qty 4 RED24	Qty 4 RET48 Qty 2 RUT06 Qty 4 RET24

108	30"	Qty 4 RES48 Qty 2 RUS06 Qty 4 RES30	Qty 4 RED48 Qty 2 RUD06 Qty 4 RED30	Qty 4 RET48 Qty 2 RUT06 Qty 4 RET30
108	3'	Qty 4 RES48 Qty 2 RUS06 Qty 4 RES36	Qty 4 RED48 Qty 2 RUD06 Qty 4 RED36	Qty 4 RET48 Qty 2 RUT06 Qty 4 RET36
108	4'	Qty 8 RES48 Qty 2 RUS06	Qty 8 RED48 Qty 2 RUD06	Qty 8 RET48 Qty 2 RUT06
114	2'	Qty 4 RES48 Qty 2 RUS12 Qty 4 RES24	Qty 4 RED48 Qty 2 RUD12 Qty 4 RED24	Qty 4 RET48 Qty 2 RUT12 Qty 4 RET24
114	30"	Qty 4 RES48 Qty 2 RUS12 Qty 4 RES30	Qty 4 RED48 Qty 2 RUD12 Qty 4 RED30	Qty 4 RET48 Qty 2 RUT12 Qty 4 RET30
114	3'	Qty 4 RES48 Qty 2 RUS12 Qty 4 RES36	Qty 4 RED48 Qty 2 RUD12 Qty 4 RED36	Qty 4 RET48 Qty 2 RUT12 Qty 4 RET36
114	4'	Qty 8 RES48 Qty 2 RUS12	Qty 8 RED48 Qty 2 RUD12	Qty 8 RET48 Qty 2 RUT12
120	2'	Qty 4 RES48 Qty 2 RUS18 Qty 4 RES24	Qty 4 RED48 Qty 2 RUD18 Qty 4 RED24	Qty 4 RET48 Qty 2 RUT18 Qty 4 RET24

120	30"	Qty 4 RES48 Qty 2 RUS18 Qty 4 RES30	Qty 4 RED48 Qty 2 RUD18 Qty 4 RED30	Qty 4 RET48 Qty 2 RUT18 Qty 4 RET30
120	3'	Qty 4 RES48 Qty 2 RUS18 Qty 4 RES36	Qty 4 RED48 Qty 2 RUD18 Qty 4 RED36	Qty 4 RET48 Qty 2 RUT18 Qty 4 RET36
120	4'	Qty 8 RES48 Qty 2 RUS18	Qty 8 RED48 Qty 2 RUD18	Qty 8 RET48 Qty 2 RUT18

### SECTION BACKS USED WITH GRID RETAINERS

Section Height	Section Width	WG 3x3	Slotgrid	Multigrid	Louvergrid	MTK 1 Side	MTK 2 Side
36	2'	RBE230WG	RBE230SG	RBE230MG	RBE230LG	RBE230M	RBE230M2
36	30"	RBE3030WG	RBE3030SG	RBE3030MG	RBE3030LG	RBE3030M	RBE3030M2
36	3'	RBE330WG	RBE330SG	RBE330MG	RBE330LG	RBE330M	RBE330M2
36	4'	RBE430WG	RBE430SG	RBE430MG	RBE430LG	RBE430M	RBE430M2
42	2'	RBE236WG	RBE236SG	RBE236MG	RBE236LG	RBE236M	RBE236M2
42	30"	RBE3036WG	RBE3036SG	RBE3036MG	RBE3036LG	RBE3036M	RBE3036M2
42	3'	RBE336WG	RBE336SG	RBE336MG	RBE336LG	RBE336M	RBE336M2
42	4'	RBE436WG	RBE436SG	RBE436MG	RBE436LG	RBE436M	RBE436M2
48	2'	RBE242WG	RBE242SG	RBE242MG	RBE242LG	RBE242M	RBE242M2
48	30"	RBE3042WG	RBE3042SG	RBE3042MG	RBE3042LG	RBE3042M	RBE3042M2
48	3'	RBE342WG	RBE342SG	RBE342MG	RBE342LG	RBE342M	RBE342M2
48	4'	RBE442WG	RBE442SG	RBE442MG	RBE442LG	RBE442M	RBE442M2

54	2'	RBE248WG	RBE248SG	RBE248MG	RBE248LG	RBE248M	RBE248M2
54	30"	RBE3048WG	RBE3048SG	RBE3048MG	RBE3048LG	RBE3048M	RBE3048M2
54	3'	RBE348WG	RBE348SG	RBE348MG	RBE348LG	RBE348M	RBE348M2
54	4'	RBE448WG	RBE448SG	RBE448MG	RBE448LG	RBE448M	RBE448M2
60	2'	RBE254WG	RBE254SG	RBE254MG	RBE254LG	RBE254M	RBE254M2
60	30"	RBE3054WG	RBE3054SG	RBE3054MG	RBE3054LG	RBE3054M	RBE3054M2
60	3'	RBE354WG	RBE354SG	RBE354MG	RBE354LG	RBE354M	RBE354M2
60	4'	RBE454WG	RBE454SG	RBE454MG	RBE454LG	RBE454M	RBE454M2
66	2'	RBE260WG	RBE260SG	RBE260MG	RBE260LG	RBE260M	RBE260M2
66	30"	RBE3060WG	RBE3060SG	RBE3060MG	RBE3060LG	RBE3060M	RBE3060M2
66	3'	RBE360WG	RBE360SG	RBE360MG	RBE360LG	RBE360M	RBE360M2
66	4'	RBE460WG	RBE460SG	RBE460MG	RBE460LG	RBE460M	RBE460M2
72	2'	RBE266WG	RBE266SG	RBE266MG	RBE266LG	RBE266M	RBE266M2
72	30"	RBE3066WG	RBE3066SG	RBE3066MG	RBE3066LG	RBE3066M	RBE3066M2
72	3'	RBE366WG	RBE366SG	RBE366MG	RBE366LG	RBE366M	RBE366M2
72	4'	RBE466WG	RBE466SG	RBE466MG	RBE466LG	RBE466M	RBE466M2
78	2'	RBE272WG	RBE272SG	RBE272MG	RBE272LG	RBE272M	RBE272M2
78	30"	RBE3072WG	RBE3072SG	RBE3072MG	RBE3072LG	RBE3072M	RBE3072M2
78	3'	RBE372WG	RBE372SG	RBE372MG	RBE372LG	RBE372M	RBE372M2
78	4'	RBE472WG	RBE472SG	RBE472MG	RBE472LG	RBE472M	RBE472M2
84	2'	RBE278WG	RBE278SG	RBE278MG	RBE278LG	RBE278M	RBE278M2
84	30"	RBE3078WG	RBE3078SG	RBE3078MG	RBE3078LG	RBE3078M	RBE3078M2
84	3'	RBE378WG	RBE378SG	RBE378MG	RBE378LG	RBE378M	RBE378M2
84	4'	RBE478WG	RBE478SG	RBE478MG	RBE478LG	RBE478M	RBE478M2
90	2'	RBE284WG	RBE284SG	RBE284MG	RBE284LG	RBE284M	RBE284M2
90	30"	RBE3084WG	RBE3084SG	RBE3084MG	RBE3084LG	RBE3084M	RBE3084M2
90	3'	RBE384WG	RBE384SG	RBE384MG	RBE384LG	RBE384M	RBE384M2
90	4'	RBE484WG	RBE484SG	RBE484MG	RBE484LG	RBE484M	RBE484M2

96	2'	RBE290WG	RBE290SG	RBE290MG	RBE290LG	RBE290M	RBE290M2
96	30"	RBE3090WG	RBE3090SG	RBE3090MG	RBE3090LG	RBE3090M	RBE3090M2
96	3'	RBE390WG	RBE390SG	RBE390MG	RBE390LG	RE390M	RE390M2
96	4'	RBE490WG	RBE490SG	RBE490MG	RBE490LG	RBE490M	RBE490M2
102	2'	Qty 2 RBE248WG	Qty 2 RBE248SG	Qty 2 RBE248MG	Qty 2 RBE248LG	Qty 2 RBE248M	Qty 2 RBE248M2
102	30"	Qty 2 RBE3048WG	Qty 2 RBE3048SG	Qty 2 RBE3048MG	Qty 2 RBE3048LG	Qty 2 RBE3048M	Qty 2 RBE3048M2
102	3'	Qty 2 RBE348WG	Qty 2 RBE348SG	Qty 2 RBE348MG	Qty 2 RBE348LG	Qty 2 RBE348M	Qty 2 RBE348M2
102	4'	Qty 2 RBE448WG	Qty 2 RBE448SG	Qty 2 RBE448MG	Qty 2 RBE448LG	Qty 2 RBE448M	Qty 2 RBE448M2
108	2'	RBE248WG RBE254WG	RBE248SG RBE254SG	RBE248MG RBE254MG	RBE248LG RBE254LG	RBE248M RBE254M	RBE248M2 RBE254M2
108	30"	RBE3048WG RBE3054WG	RBE3048SG RBE3054SG	RBE3048MG RBE3054MG	RBE3048LG RBE3054LG	RBE3048M RBE3054M	RBE3048M2 RBE3054M2
108	3'	RBE348WG RBE354WG	RBE348SG RBE354SG	RBE348MG RBE354MG	RBE348LG RBE354LG	RBE348M RBE354M	RBE348M2 RBE354M2
108	4'	RBE448WG RBE454WG	RBE448SG RBE454SG	RBE448MG RBE454MG	RBE448LG RBE454LG	RBE448M RBE454M	RBE448M2 RBE454M2
114	2'	RBE248WG RBE260WG	RBE248SG RBE260SG	RBE248MG RBE260MG	RBE248LG RBE260LG	RBE248M RBE260M	RBE248M2 RBE260M2
114	30"	RBE3048WG RBE3060WG	RBE3048SG RBE3060SG	RBE3048MG RBE3060MG	RBE3048LG RBE3060LG	RBE3048M RBE3060M	RBE3048M2 RBE3060M2
114	3'	RBE348WG RBE360WG	RBE348SG RBE360SG	RBE348MG RBE360MG	RBE348LG RBE360LG	RBE348M RBE360M	RBE348M2 RBE360M2
114	4'	RBE448WG RBE460WG	RBE448SG RBE460SG	RBE448MG RBE460MG	RBE448LG RBE460LG	RBE448M RBE460M	RBE448M2 RBE460M2
120	2'	RBE248WG RBE266WG	RBE248SG RBE266SG	RBE248MG RBE266MG	RBE248LG RBE266LG	RBE248M RBE266M	RBE248M2 RBE266M2
120	30"	RBE3048WG RBE3066WG	RBE3048SG RBE3066SG	RBE3048MG RBE3066MG	RBE3048LG RBE3066LG	RBE3048M RBE3066M	RBE3048M2 RBE3066M2
120	3'	RBE348WG RBE366WG	RBE348SG RBE366SG	RBE348MG RBE366MG	RBE348LG RBE366LG	RBE348M RBE366M	RBE348M2 RBE366M2
120	4'	RBE448WG RBE466WG	RBE448SG RBE466SG	RBE448MG RBE466MG	RBE448LG RBE466LG	RBE448M RBE466M	RBE448M2 RBE466M2



# Uprites

- 3/16" thick face channel
- 1" slotted on center for maximum flexibility
- Use for Wall and Island Sections
- Steel welded construction
- Includes side flanges to retain Back material, leveling leg for uneven floors
- Includes Top Caps on Uprites 36"-66"H

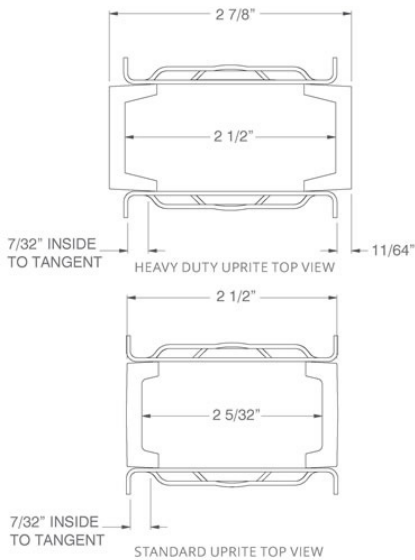

## Product Options and Numbers

Example Part #: **U 42 PLT**

**Uprite:** **U**, UH

**U Height:** 30", 36", **42"**, 48", 54", 60", 66", 72", 78", 84", 90", 96", 102", 108", 114", 120"

**UH Height:** 72", 78", 84", 90", 96", 108", 120"

**Standard Finish:** **PLT**, Optional Catalog Colors

### Suffix Key

PLT	- Platinum
U	- Uprite

## Base Set

---

- 06 or Low Base height
- Standard or Heavy Duty
- Starter and Add-On

Order 1 for each side of the gondola section (Starter or Add-On)

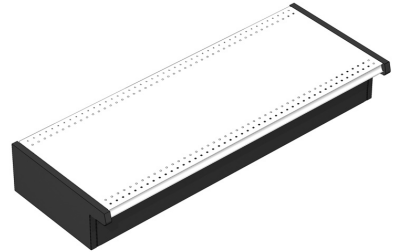

## Product Options and Numbers

### INCLUDES:

- A. Base Bracket(s) (Standard or Heavy Duty)
- B. Base Front (Open or Closed)
- C. S-Series Deck (Standard Duty-Optional Reinforced)
- D. Base End Trim

### BASE SET

**Type:** Add On, Starter

**Base Bracket Style:** Heavy Duty, Standard Duty

**Width:** 2', 30", 3', 4'

**Depth:** 13", 16", 19", 22", 25", 28", 31"

**Deck Style:** Heavy Duty, S-Style, S-Style Reinforced

**Molding Type:** M13 Painted, M13 Satin, M35 Painted, M35 Satin, M55 Painted, M55 Satin, No Molding, MR1 Painted, MR1 Satin

**Base Height:** 06 Base, Low Base

**Base Front Style:** Closed, Open

**Base Finish:** CHR

**Deck Finish:** PLT Optional Catalog Colors

**Deck Top Finish:** LAX Optional Catalog Laminates (Laminated Decks Only-Requires MR1 Molding)

**Molding Finish:** Omit No Molding, SAT, PLT Painted Optional Catalog Colors

**STARTER**

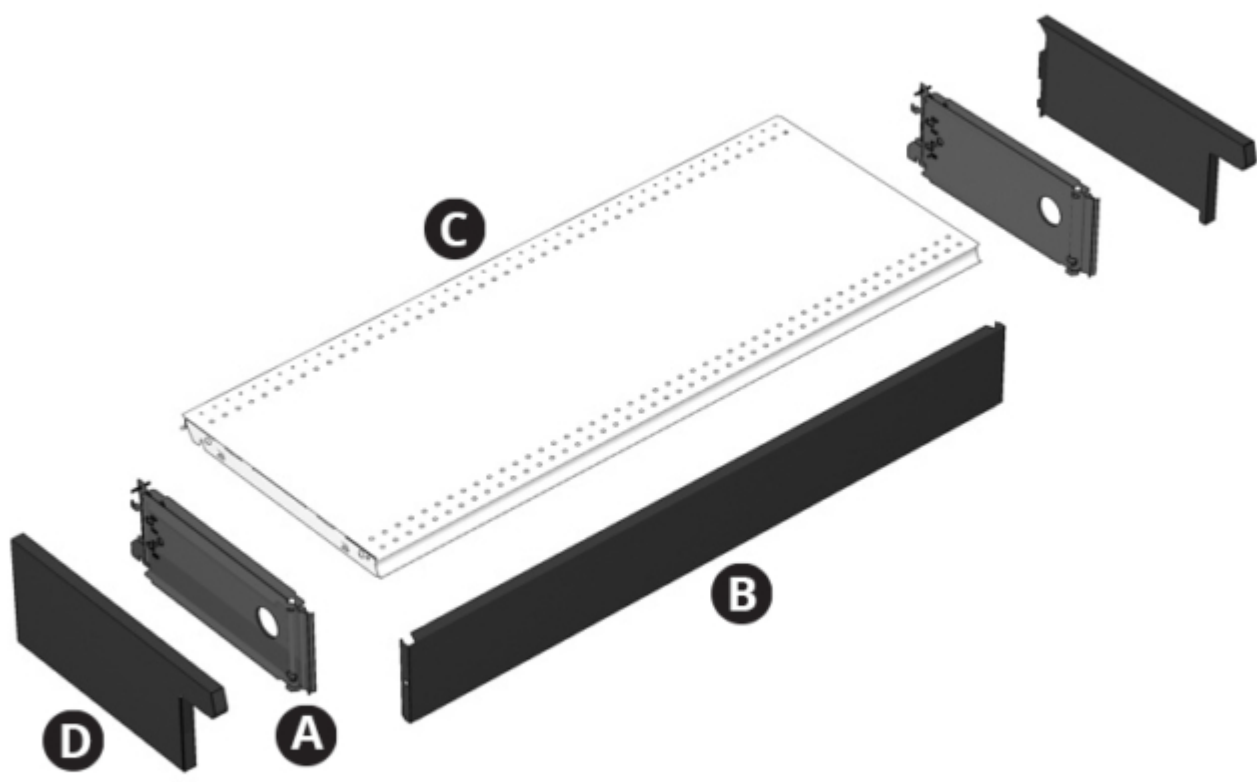

ADD-ON

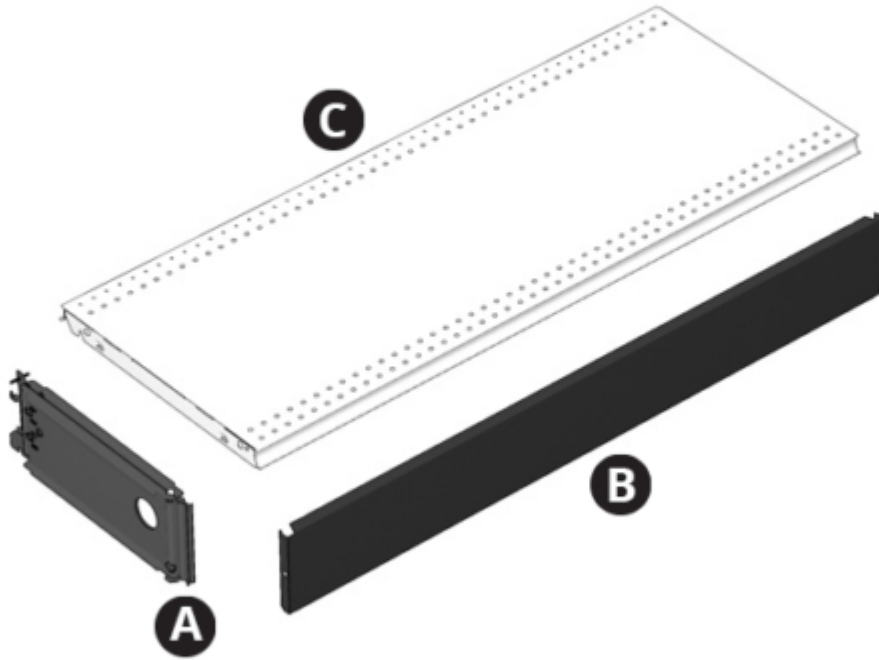

### Suffix Key

<b>CHR</b>	- Charcoal Black
<b>LAX</b>	- Platinum Laminate
<b>PLT</b>	- Platinum
<b>SAT</b>	- Satin Molding
<b>M13</b>	- M13 Tag Molding
<b>M35</b>	- M35 Tag Molding
<b>M55</b>	- M55 Tag Molding

## Top Rail

---

- All Island and Wall Sections require one Top, Center and Bottom Rail
- 2' and 30" sections use two Top Rails to make a Splicer Rail
- Electrical knockouts included on all Rails

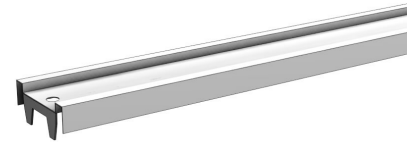

### Product Options and Numbers

Example Part #: **R 4 T PLT**

Rails:**R**

Width: 2', 30", 3', **4'**

Top Rail: **T**

Standard Finish: **PLT**, Optional Catalog Colors

#### Suffix Key

**PLT** - Platinum Color

## Splicer Rail

---

- All Island and Wall Sections require one Top, Center and Bottom Rail
- 78"H - 144"H Backs require one Splicer Rail
- Splicer rail is not available in 2' or 30"
- Use two top rails for splicer rail on 2' and 30" wide sections.
- Electrical knockouts included on all Rails

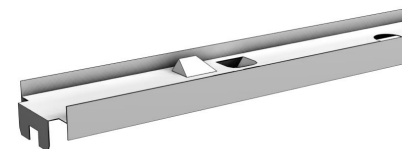

### Product Options and Numbers

Example Part #: **R 4 S PLT**

Rails:**R**

Width: 3', **4'**

## Splicer Rail: **S**

Standard Finish: **PLT**, Optional Catalog Colors

### Suffix Key

**PLT** - Platinum Color

## Wire Grid Assembly Bottom Rail

---

- Use standard duty for 3x3 Grid and Slot Grid, applications less than 36"W
- Heavy duty option for higher load needs
- Use heavy duty for Louver Grid and Multi-Grid 36"W or 48"W in double or triple back applications

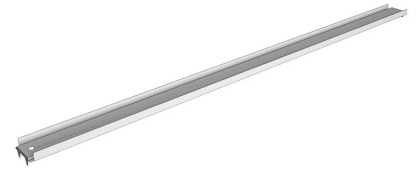

## Product Options and Numbers

Example Part #: **BRHD 4 PLT**

Wire Grid Assembly Bottom Rail: BR, **BRHD** (3' & 4' only)

Width: 2', 30", 3', **4'**

Standard Finish: **PLT**, Optional Catalog Colors

### Suffix Key

**BR** - Bottom Rail  
**BRHD** - Heavy Duty Bottom Rail  
**PLT** - Platinum Color

## Wire Grid Assembly Retainers

---

- Wire Backs require perimeter retainers to adapt them for use in standard Lozier Uprites
- For the most efficient length configuration, order lengths per the Wire Back Assembly
- Order two RE\_ to be used in the horizontal application
- Order a minimum two RE\_ to be used in the vertical application
- For sections taller than 54"H (RE\_48) and up to 96", order RU\_upper retainer to correspond to the overall Back height
- For Backs taller than 96"H order one Splicer Rail (R\_S), two horizontal retainers (RE\_), and two vertical retainers (RE\_)



S = Single Back



D = Double Back



T = Triple Back

## Product Options and Numbers

Example Part #: **RE S 48 PLT**

**Wire Grid Assembly Retainer:** RE,RU

**Retainer Style:** S,D, T

**Height:** 06", 12", 18", 24", 30", 36", 42", **48"**

**Standard Finish:** **PLT**, Optional Catalog Colors

### Suffix Key

<b>RE</b>	- Extension Back Retainer
<b>RU</b>	- Upper Back Retainer
<b>S</b>	- Single Back Retainer
<b>D</b>	- Double Back Retainer
<b>T</b>	- Triple Back Retainer
<b>PLT</b>	- Platinum



## Wire Back Retainer Extensions

---

- Choose the Back style that meets your visual merchandising needs
- Order RBE\_ 6" shorter than Uprite (Example: U72, order RBE466WG. One-piece backs up to 90"H)

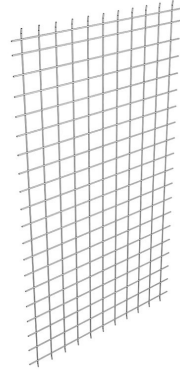

WG = 3x3 Wire Grid



SG = Slot Grid



MG = Multi-Grid



LG = Louver Grid

### Product Options and Numbers

Example Part #: **RBE 4 54 WG PLT**

Wire Back Retainer Extension: **RBE**

Width: 2', 30", 3', **4'**

Height: 06", 12", 18", 24", 30", 36", 42", 48", **54"**, 60", 66", 72", 78", 84", 90"

Back Style: **WG**, SG, LG, MG, P, M, ME, P2, M2

Standard Finish: **PLT**, Optional Catalog Colors

#### Suffix Key

<b>WG</b>	- 3 x 3 Wire Grid Back
<b>SG</b>	- Slot Grid Back

<b>LG</b>	- Louver Grid Back
<b>MG</b>	- Multi-Grid Back
<b>P</b>	- Pegboard Back
<b>M</b>	- Marteck Back
<b>ME</b>	- Econo Marteck Back
<b>P2</b>	- Single Pegboard Back, painted two sides
<b>M2</b>	- Single Marteck Back, painted both sides
<b>PLT</b>	- Platinum

## Uprite and Extension Uprite End Trim

---

- One-piece trim (Two-pieces if 102"-144"H) snaps onto first and last Uprite or Extension Uprite in a run
- Can be used on both sides of Extension Uprites where Extension Backs are not used



### Product Options and Numbers

Example Part #: **UET 48 PLT**

Uprite/Extension Uprite End Trim: **UET**

Height: 6", 12", 18", 24", 30" 36", 42", **48"**, 54", 60", 66", 72", 78", 84", 90", 96", 102", 108", 114", 120"

Standard Finish: **PLT**, Optional Catalog Colors

#### Suffix Key

**PLT** - Platinum